

JAM™

TURNTABLE



INSTRUCTION MANUAL

HX-TT600A

2 YEAR GUARANTEE

JAM guarantees this product from defect in material and workmanship for a period of 2 years from the date of purchase, except as noted below. This JAM product guarantee does not cover damage caused by misuse or abuse; accident; the attachment of any unauthorised accessory; alteration to the product; or any other conditions whatsoever that are beyond the control of JAM. This guarantee is effective only if the product is purchased and operated in the UK / EU. A product that requires modification or adaptation to enable it to operate in any country other than the country for which it was designed, manufactured, approved and / or authorised, or repair of products damaged by these modifications is not covered under this guarantee. JAM shall not be responsible for any type of incidental, consequential or special damages. Please note, the stylus cartridge is easily damaged and is NOT included in the product warranty. For replacement stylus cartridges, please contact Customer Service.

To obtain guarantee service on your product, return the product post-paid to your local service centre along with your dated sales receipt (as proof of purchase). Please refer to 'JAM Service Centre' information leaflet for details of your local service centre. Upon receipt, JAM will repair or replace, as appropriate, your product and return it to you, post-paid. Guarantee is solely through JAM Service Centre. Service of this product by anyone other than the JAM Service Centre voids the guarantee.

This guarantee does not affect your statutory rights.

CUSTOMER SERVICE

@ uksupport@jamaudio.com

✉ FKA Brands Ltd, Somerhill Business Park,

Five Oak Green Rd, Tonbridge, Kent, TN11 0GP, UK

☎ +44 (0) 203 538 0768

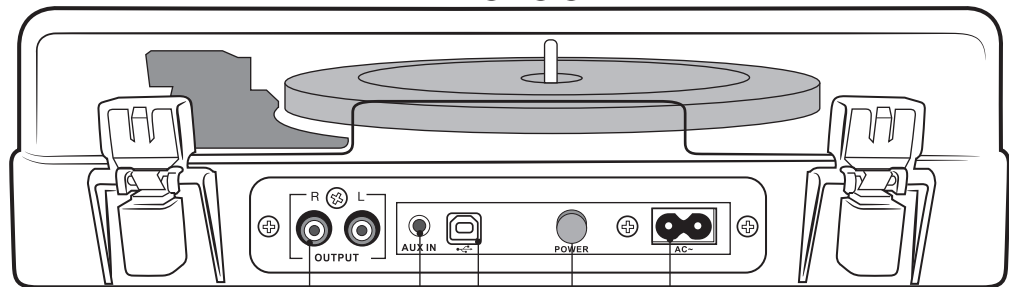
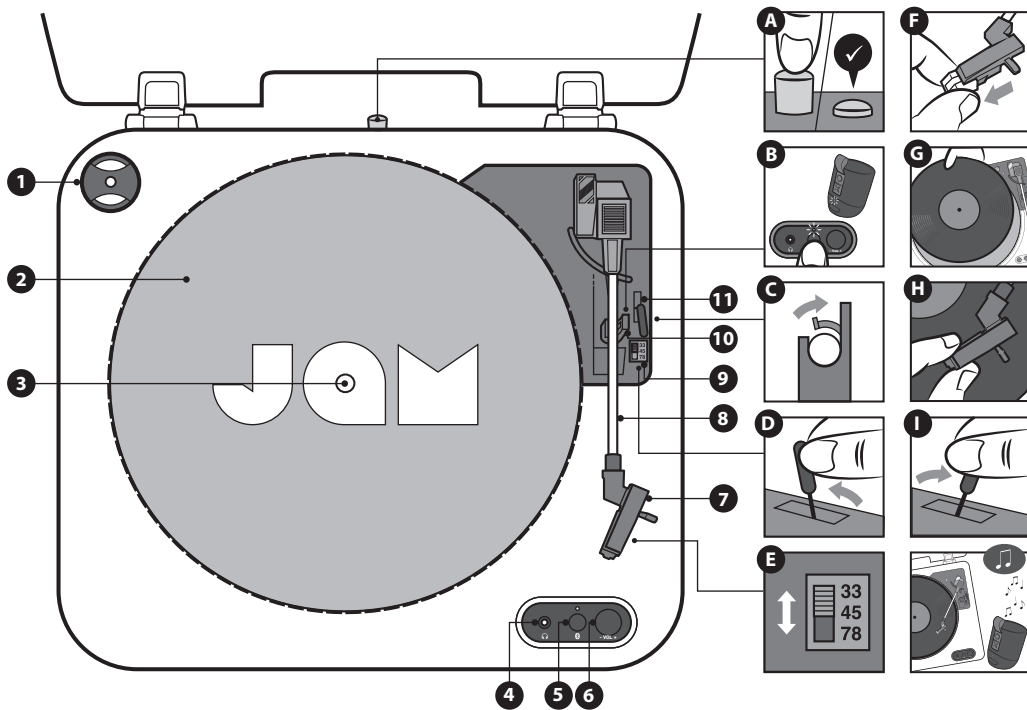

RCA to AUX cable (included)



RCA to RCA cable (available separately)

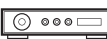

1. 45 rpm adaptor
2. Turntable
3. Spindle
4. Earplug jack
5. Bluetooth pair button
6. - vol + knob
7. Stylus
8. Tone arm
9. 33/45/78 rpm speed selector
10. Arm lock
11. Tone arm lift lever
12. RCA output sockets
13. Aux-in socket
14. USB socket
15. Power button
16. Ac power socket

WHAT'S IN THE BOX

Turntable, platter mat, RCA to AUX cable, USB cable, AC power cord.

USING THE TURNTABLE

Plug the supplied power cord into the AC power socket on the back of the turntable and connect to the mains.

Ensure the unit is on by pressing in the power button **A**.

Ensure the Bluetooth device you want to connect to, is turned on and in pairing mode. Then press the Bluetooth pair button on the turntable. The light will flash blue when searching for the device to pair to. Once found and paired the turntable indicator will be solid blue **B**.

TIP: If taking a while to pair (+30 secs), press the Bluetooth pair button on the turntable 1 more time to re-initiate the searching feature.

Remove the tone arm lock **C**.

Push the lift handle to raise the tone arm **D**.

Select the speed - 33 $\frac{1}{3}$, 45 or 78 rpm as required **E**.

Remove the white plastic needle guard **F**. Keep this in a safe place, you'll need to put it back on when you're finished.

Put a record on the turntable **G**.

Move the tone arm to the desired position on the record **H**.

The record will start turning as the tone arm moves across.

Pull the lift handle forward to lower the tone arm and the record will start playing **I**.

When you have finished, manually remove the tone arm from the record by using the lift handle **D** and return to the rest holder. The record will stop turning at this point. Press the power button to switch off the turntable.

NOTE: Standby mode. The main unit will switch to standby mode when the turntable is idle for approximately 15 minutes. Once the unit turns into standby mode, Press POWER button to turn the unit off and then press POWER button again to turn the unit back on.

CONNECTING TO SPEAKERS OR OTHER DEVICES

Caution:

- Switch off the power to all equipment before making connections.
- Read the instructions of each component you intend to use with this unit.
- Be sure to insert each plug securely. To prevent hum and noise, avoid bundling the signal interconnection cables together with the AC power cord.

Connecting to a device with RCA input

To connect the turntable to devices with RCA input, use an RCA to RCA cable (available separately). Connect the RCA plugs on one end of the cable to the L and R sockets on the back of the turntable and the plugs at the other end to the corresponding L and R sockets on the back of the device.

Connecting to a device with AUX input

To connect the turntable to a device with an AUX input, use a RCA to AUX cable (included). Connect the RCA plugs to the L and R sockets on the back of the turntable and the AUX plug to the AUX socket on the back of the device.

Headphone Operation

1. Connect a set of headphone (not included) on the Earphone socket on the front panel of the unit.
2. Put on the headphone and slowly increase the volume until you can hear it clearly and comfortably without distortion.

NOTE: Never put on the headphone till you have plugged in the headphone plug and turn down the volume level.

USING THE 45 RPM ADAPTOR

The 45 RPM adaptor allows you to play 45 RPM records:



1. Place the 45 RPM adaptor over the spindle
2. Gently place your 45 RPM record onto the turntable
3. Follow the operation instructions left to play your record.

MAINTENANCE

- DO NOT leave vinyl records on the turntable after use. Return the vinyl record to its original packaging and store.
- Return the tone arm to its original place after use and secure with tone arm lock.
- Replace the white plastic needle guard after use. Close the turntable cover to avoid dust damage.
- Unplug the power cable and other cables after use.
- Please note, the stylus cartridge can be easily damaged and is **NOT included in the product warranty**. For replacement stylus cartridges, please contact Customer Service (details on back of this leaflet).

USB TO PC RECORDING

Audacity Software - can be downloaded from: www.audacityteam.org/download/ Full instructions for the Audacity Software USB-PC Functions can be found at: manual.audacityteam.org

WEEE EXPLANATION

This marking indicates that this product should not be disposed with other household wastes throughout the EU. To prevent possible harm to the environment or human health from uncontrolled waste disposal, recycle it responsibly to promote the sustainable reuse of material resources.

LISTEN RESPONSIBLY

To prevent possible hearing damage, do not listen at high volume levels for long periods.

SPECIFICATIONS

General

Power Requirements	AC 230V~50Hz
Dimensions (W x D x H)	38 x 30 x 12cm
Weight	3.2 kgs

Record Player Section

Motor	DC servo motor
Drive System	Belt Drive
Speeds	Off/33 $\frac{1}{3}$ rpm, 45 rpm, 78rpm
S/N Ratio	55 Db(AUX-IN)
RCA Out	200-280 mV (5 cm/sec at 1 KHz-10dB)
Stylu	M02-M208-165
Cartridge Type	Ceramic Stereo Cartridge

Bluetooth Transmit

Bluetooth Version	Bluetooth V5.1
Bluetooth Profiles	A2DP, AVRCP
Operating Distance	7meters (22.97 ft.)

USB

Type	USB series B connector
Full-Speed	USB 2.0 full speed

READ ALL INSTRUCTIONS BEFORE USE. SAVE THESE INSTRUCTIONS FOR FUTURE REFERENCE.

IMPORTANT SAFEGUARDS





WHEN USING ELECTRICAL PRODUCTS, ESPECIALLY WHEN CHILDREN ARE PRESENT, BASIC SAFETY PRECAUTIONS SHOULD ALWAYS BE FOLLOWED, INCLUDING THE FOLLOWING:

- ALWAYS unplug the appliance from the electrical outlet immediately after using and before cleaning. To disconnect, turn all controls to the 'OFF' position, then remove plug from outlet.
- Power cable MUST be removed from socket otherwise the cable is still live.
- NEVER leave an appliance unattended when plugged in. Unplug from the mains outlet when not in use and before putting on or taking off parts or attachments.
- This appliance can be used by children aged from 14 years and above and persons with reduced physical, sensory or mental capabilities or lack of experience and knowledge if they have been given supervision or instruction concerning use of the appliance in a safe way and understand the hazards involved. Children shall not play with the appliance. Cleaning and user maintenance shall not be made by children without supervision.
- DO NOT reach for an appliance that has fallen in water or other liquids. Switch off at the mains and unplug it immediately. Keep dry – DO NOT operate in wet or moist conditions.
- NEVER insert pins or other metallic fasteners into the appliance.
- Use this appliance for the intended use as described in this booklet. DO NOT use attachments not recommended by Jam Audio.
- NEVER operate the appliance if it has a damaged cord or plug, if it is not working properly, if it has been dropped or damaged, or dropped into water. Return it to the HoMedics Service Centre for examination and repair.
- Keep cord away from heated surfaces.
- Excessive use could lead to the product's excessive heating and shorter life. Should this occur, discontinue use and allow the unit to cool before operating.
- NEVER drop or insert any object into any opening.

- DO NOT operate where aerosol (spray) products are being used or where oxygen is being administered.
- DO NOT carry this appliance by the cord or use cord as a handle.
- DO NOT use outdoors.
- This product requires a 230 V AC power supply.
- DO NOT attempt to repair the appliance. There are no user serviceable parts. For service, send to a HoMedics Service Centre. All servicing of this appliance must be performed by authorised HoMedics service personnel only.
- Never block the air openings of the appliance or place it on a soft surface, such as a bed or couch. Keep air openings free of lint, hair etc.
- Do not place or store appliance where it can fall or be pulled into a bath or sink. Do not place in or drop into water or other liquid.
- Failure to follow the above may result in the risk of fire or injury.

Hereby, FKA Brands Ltd., declares that this radio device is in compliance with the essential requirements and other relevant provisions of Directive 2014/53/EU. A copy of the Declaration of Conformity can be obtained from uk.jamaudio.com/DoC

Bluetooth Frequency range: 2.402GHz-2.480GHz
Maximum radio-frequency power: 3.12dBm

	<p>RECYCLING This product bears the selective sorting symbol for Waste electrical and electronic equipment (WEEE). This means that this product must be handled pursuant to European directive 2012/19/EU in order to be recycled or dismantled to minimize its impact on the environment. User has the choice to give his product to a competent recycling organization or to the retailer when he buys a new electrical or electronic equipment</p>
	<p>This symbol indicates class II equipment</p>
	<p>This symbol indicates AC voltage</p>
	<p>This symbol indicates for indoor use only</p>
<p>The power adaptor plug is used as the disconnect device, The connected AC power outlet must be located near the equipment and be easily accessible.</p>	
<p>The marking information is located at the bottom of the apparatus.</p>	